

Common User Data

Machine Name: Xerox VersaLink C415 Color MFP (46:2...
 IP Address: 10.61.16.62
 Machine Serial Number: YCQ293082
 Fax Line1:
 Machine URL: https://10.61.16.62
 Machine Activation Date: Jul 18, 2024 17:05:04
 Black Impressions: 783
 Color Impressions: 3401
 Total Impressions: 4184

Machine Profile

Xerox Asset Tag:
 Customer Asset Tag:
 Service Phone Number:
 Customer Support Number:
 Supplies Phone Number:
 System Administrator: System Administrator name not set
 Machine Location: machine location not set
Managed By
 Primary MB Server:

Machine Hardware

Fax Card: Not Present
 Fax Memory Size: 0 MB
 Foreign Interface Card: not present
 Device RAM Size: 1984 MB
 Device Storage Size: used=3064MB/total=14004MB (eMMC)
 EPC Memory Size: 187 MB
 Productivity Kit: Not Installed
 Finisher Type: Simple Catch Tray
 Finisher Punch: None
 Finisher Folder: not present
 Multi-feed Detection Kit: Not Installed

General Setup

Remote Services: Enabled
 Remote Software Download: Enabled
 Remote Services Trans. Time: 14:05
 Xerox Workplace Cloud: Disabled
 E-mail Alerts: Disabled
 Service Plan: Metered
 Geographic Region: unknown
 GMT Offset: +05:30
 Cloning Installation: Allowed (Encrypted Files Only)
 File Sharing: Enabled
 JBIG2: Lossless
Energy Saver
 Deep Sleep: Enabled
 Energy Saver Mode: Job Activated
Smart Proximity Sensor
 Wake on Arrival: Not Available
 Sleep on Departure:

Software Versions

Device Software: 122.028.004.32300
 Patch Version: None
 Network Controller: 122.028.32300
 UI Panel Firmware: 6.2
 Marking Engine: 230.314
 Document Feeder: 230.314
 Finisher: 000.000.000
 Fax: 000.000.000
 Scanner: 230.314
Machine Upgrades:
 Last Successful Upgrade: November 20, 2024 13:08:42

Media Trays

Tray 1: Plain, White and A4 (210 x 297 mm)
 Manual Feeder: Plain, White and A4 (210 x 297 mm)

Installed Options

PS: Installed

Connectivity

Mobile Workflows

AirPrint Printing: Enabled
 Mopria Printing Discovery: Enabled
 AirPrint / Mopria Scanning Authentication: Enabled
 Disabled
Physical Connections
USB Settings
 USB Type A Ports: All Enabled
 USB Type B Port: Enabled
Wired:
 Ethernet MAC Address: Enabled
 Ethernet Speed/Duplex Setting: 78.8c:77:46:20:25 auto
 Disabled
Wireless:
 Wireless MAC Address:
 Network Name (SSID):
 BSSID:
 Security Mode:
 Encryption Algorithm:
 Status:
Wi-Fi Direct: Enabled
 Wireless Hardware: Not Installed
 Wi-Fi Protected Setup (WPS) Name:
 Access Point (SSID):
 Show Password on Device Touch Screen:
NFC: Enabled
 iBeacon (Bluetooth®) for AirPrint Di...: Enabled
 iBeacon Hardware: Not Installed
 Bluetooth Device Address:
 iBeacon IP Address:

Protocols

TCP/IPV4: Enabled
 IP Address: 10.61.16.62
 Subnet Mask: 255.255.255.0
 Router/Gateway: 10.61.16.1
 Automatic Addressing: DHCP
 DHCP Server: 10.61.13.224
 DHCP Lease Expiration: Fri Nov 29 15:56:09 2024
 BOOTP Broadcast: Disabled
 Self Assigned Address State: Enabled
 Self Assigned Address:
TCP/IPV6: Enabled
 Link Local Address: fe80::7a8c:77ff:fe46:2025
 Use Router Supplied Prefix: Enabled
 Stateless Global Address 1: fd00:0:2:116:7a8c:77ff:fe46:2025
 Stateless Global Address 2: ::
 Manual Address:
 DHCP Addressing: Use DHCP as directed by a router
 DHCP Address:
 Default Gateway: fe80::8afc:5dff:fe75:e282
 DUID (DHCP Unique Identifier):
DNS Settings:
 Requested Host Name: XRX788C77462025
 Verified Host Name:
 Requested Domain Name:
 Verified Domain Name:
 Multicast DNS: Enabled
 Release DHCP Leases and DNS Registrati...: Disabled
 Primary DNS Server: 10.61.7.15
 Prefer IPv6 DNS over IPv4: Enabled

Bonjour:

Bonjour Printer Name: Xerox VersaLink C415 Color MFP (46:2...
HTTP: Enabled
 Force Traffic over Secure Connection (H...: Yes
 IPP: Enabled

SNMP

SNMP v1/v2: Enabled
 SNMP v3: Disabled

LPR/LPD:

Enabled

Raw IP Printing:

Enabled

LDAP

LDAP Server 1 Primary LDAP Address: 0.0.0.389
 LDAP Server 1 Search Directory Root:
 LDAP Server 1 Secure Connection (LDA...: Disabled
 LDAP Server 1 Validate Server Certificate...: Disabled

SMTP

SMTP Server: 0.0.0.25
 Connect Encryption (TLS): No Encryption
 Validate Server Certificate (TLS):

Protocols (cont.)

POP3	
POP3 Server:	0.0.0.0:110
POP3 Secure Connection (TLS):	Disabled
E-mail Address:	
NTP:	Disabled
FTP Client:	Enabled
FTP Client Mode:	Passive
Web Services on Device:	Enabled

Apps**Printing**

Banner Sheet:	Disabled
Error Sheets:	Enabled
Paper Substitution:	Enabled
Tray Priority:	1,5
Archival Marking Mode	Off
PostScript	Installed
Level:	3
Version:	3021.101
PCL	
Version:	6
Font Name:	Courier
Custom Color Tables	Enabled
Label:	Not Installed
Fax:	Not Present
Fax Line1:	
Fax Line2:	

Server Fax:

Repository Protocol:	Enabled
Repository Server:	FTP
Repository Document Path:	0.0.0.0

Workflow Scanning:

	Enabled
--	---------

Email:

	Enabled
--	---------

Scan to Mailbox:

	Enabled/Displayed
Storage Capacity (MB):	672 MB
Storage Used (MB):	49 MB
Cleanup of Public Folders:	Enabled
Cleanup of Created Folders:	Enabled
Cleanup Time:	Daily

Scan to Home:

	Disabled
--	----------

Scan To:

Cloud Services:	Enabled
-----------------	---------

Print From:

Cloud Services:	Disabled
Saved Jobs for Reprint:	Enabled
Print From USB:	Enabled
Print From MailBox:	Disabled
Cloud Services:	Disabled

Accounting

Accounting Mode:	None
Network Accounting:	Disabled

Security**Authentication Configuration**

Machine UI Authentication:	Locally on the Device
Home:	Unlocked
Jobs:	Unlocked
Device:	Unlocked
Device Website Authentication:	Locally on the Device
Authorization:	Locally on the Device
Retrieve E-mail from LDAP:	Enabled

Authentication Server:

	Kerberos
--	----------

Xerox Secure Access:

	Disabled
--	----------

Audit Log:

	Enabled
--	---------

IP Sec:

	Disabled
--	----------

IP Filtering:

	Disabled
--	----------

Security Certificates

Machine Certificate:	Signed
----------------------	--------

802.1x:

Root Certificates Installed:	56
	Disabled

Job Data Removal:

Scheduled:	Disabled
------------	----------

FIPS 140-3:

	Disabled
--	----------

TLS:

	TLS 1.1 and TLS 1.2
--	---------------------

TLS Hash:

	SHA-1, SHA-256 and above
--	--------------------------

Trellix Embedded Control:

	Disabled
--	----------

Common User Data

Machine Name: Xerox VersaLink C415 Color MFP (46:2...
 IP Address: 10.61.16.62
 Machine Serial Number: YCQ293082
 Fax Line1:
 Machine URL: https://10.61.16.62
 Machine Activation Date: Jul 18, 2024 17:05:04
 Black Impressions: 784
 Color Impressions: 3402
 Total Impressions: 4186

Machine Profile

Xerox Asset Tag:
 Customer Asset Tag:
 Service Phone Number:
 Customer Support Number:
 Supplies Phone Number:
 System Administrator: System Administrator name not set
 Machine Location: machine location not set
Managed By
 Primary MB Server:

Machine Hardware

Fax Card: Not Present
 Fax Memory Size: 0 MB
 Foreign Interface Card: not present
 Device RAM Size: 1984 MB
 Device Storage Size: used=3065MB/total=14004MB (eMMC)
 EPC Memory Size: 187 MB
 Productivity Kit: Not Installed
 Finisher Type: Simple Catch Tray
 Finisher Punch: None
 Finisher Folder: not present
 Multi-feed Detection Kit: Not Installed

General Setup

Remote Services: Enabled
 Remote Software Download: Enabled
 Remote Services Trans. Time: 14:05
 Xerox Workplace Cloud: Disabled
 E-mail Alerts: Disabled
 Service Plan: Metered
 Geographic Region: unknown
 Startup Config Report: Disabled
 GMT Offset: +05:30
 Cloning Installation: Allowed (Encrypted Files Only)
 Allow Print Submission of Clone Files: Enabled
 File Sharing: Enabled
 JBIG2: Lossless
Energy Saver
 Deep Sleep: Enabled
 Energy Saver Mode: Job Activated
 Sleep Mode Timer: 120 minutes
 Auto-Off: Disabled

Software Versions

Device Software: 122.028.004.32300
 Patch Version: None
 Network Controller: 122.028.32300
 UI Panel Firmware: 6.2
 User Interface: 122.028.32300
 Marking Engine: 230.314
 Copy Controller: 122.028.32300
 Document Feeder: 230.314
 Finisher: 000.000.000
 Fax: 000.000.000
 OS: 230.314
 Scanner: 230.314
 Software Upgrade: 005.007
 ALTBQOT Software Upgrade: 005.007
Machine Upgrades:
 Last Successful Upgrade: Allowed
 Scheduled Auto Upgrades: November 20, 2024 13:08:42
 Auto Upgrade Start Time: Disabled
 Auto Upgrade Server: Daily
 Auto Upgrade Server: 0.0.0.21

Media Trays

Tray 1: Plain, White and A4 (210 x 297 mm)
 Manual Feeder: Plain, White and A4 (210 x 297 mm)

Connectivity

Mobile Workflows

AirPrint Printing: Enabled
 Mopria Printing Discovery: Enabled
 AirPrint / Mopria Scanning: Enabled
 Authentication: Disabled
 Universal Print: Disabled
 Universal Print Registration Status: Not Registered

Physical Connections

USB Settings
 USB Type A Ports: All Enabled
 USB Type B Port: Enabled
 Connection Timeout: 5 seconds
Wired:
 Ethernet MAC Address: 78:8c:77:46:20:25
 Ethernet Speed/Duplex Setting: auto
Wireless:
 Wireless MAC Address: Disabled

Network Name (SSID):
 BSSID:
 Security Mode:
 Encryption Algorithm:
 Status:
Wi-Fi Direct:
 Wi-Fi Protected Setup (WPS) Name:
 Connection Method:
 Subnet Prefix Address:
 Access Point (SSID):
 Show Password on Device Touch Screen:
NFC:
 iBeacon (Bluetooth®) for AirPrint Di...
 iBeacon Hardware: Not Installed
 Bluetooth Device Address:
 iBeacon IP Address:

Protocols

TCP/IPV4:

IP Address: Enabled
 10.61.16.62
 Subnet Mask: 255.255.255.0
 Router/Gateway: 10.61.16.1
 Automatic Addressing: DHCP
 DHCP Server: 10.61.13.224
 DHCP Lease Expiration: Fri Nov 29 15:56:09 2024
 BOOTP Broadcast: Disabled
 Self Assigned Address State: Enabled
 Self Assigned Address:

TCP/IPV6:

Link Local Address: Enabled
 fe80::7a8c:77ff:fe46:2025
 Use Router Supplied Prefix: Enabled
 Stateless Global Address 1: fd00:0:2:116:7a8c:77ff:fe46:2025
 Stateless Global Address 2: ::
 Manual Address:
 DHCP Addressing: Use DHCP as directed by a router
 DHCP Address:
 Default Gateway: fe80::8afc:5dff:fe75:e282
 DUID (DHCP Unique Identifier):

DNS Settings:

Requested Host Name: XRX788C77462025
 Verified Host Name:
 Requested Domain Name:
 Verified Domain Name:
 Multicast DNS:
 Release DHCP Leases and DNS Registrati...
 Primary DNS Server: Enabled
 10.61.7.15
 Alternate DNS Server 1: 10.61.10.6
 Alternate DNS Server 2: ::
 DNS Connection Timeout: 5
 Append Device Domain: Enabled
 Append Parent Domains: Disabled
 DNS Domain Search List: XEROXQA.COM.
 Prefer IPv6 DNS over IPv4: Enabled

Installed Options

PS: Installed

Protocols (cont.)

Bonjour:
 Bonjour Printer Name: Xerox VersaLink C415 Color MFP (46.2...)

HTTP:
 Port Number: Enabled
 80
 Force Traffic over Secure Connection (H... Yes
 Secure HTTP Port Number: 443
 Proxy Server: Disabled
 Proxy Server Address: 0.0.0.0:8080
 IPP: Enabled
 Secure IPP Mode: IPP and Secure IPPS
 IPP Network Path: http://10.61.16.62:631

SNMP
 SNMP v1/v2: Enabled
 SNMP v3: Disabled

LPR/LPD:
 Enabled
 Port Number: 515
 PDL Switching: Enabled
 PDL Banner Override: Enabled

Raw IP Printing:
 Enabled
 Port Number 1: 9100
 Bidirectional: Disabled
 End of Job Timeout: 300
 PDL Switching: Disabled

LDAP
 LDAP Server 1 Friendly Name:
 LDAP Server 1 Primary LDAP Address: 0.0.0.0:389
 LDAP Server 1 Alternate LDAP Address: 0.0.0.0:389
 LDAP Server 1 Search Directory Root:
 LDAP Server 1 Secure Connection (LDA... Disabled
 LDAP Server 1 Validate Server Certificate... Disabled

SMTP
 SMTP Server: 0.0.0.0:25
 Connect Encryption (TLS): No Encryption
 Validate Server Certificate (TLS):
 Max Message Size (KB): 10240
 Number of Fragments: 1
 Total Job Size (KB): 300000
 Job Splitting Boundary: Page Boundary
 Credentials for Auto E-mails: None
 Credentials for Walkup User: None

POP3
 POP3 Server: 0.0.0.0:110
 POP3 Secure Connection (TLS): Disabled
 E-mail Address:
 Receipt of E-mail via POP3: Disabled
 Send Confirm on Request: Enabled
 Incoming E-mail cover sheet: Enabled

NTP:
 Disabled
 Primary Server: 0.0.0.0:123
 Alternate Server: 0.0.0.0:123

SLP:
 Disabled

FTP Client:
 Enabled
 FTP Client Mode: Passive

Web Services on Device:
 Enabled
 WS-Discovery: Enabled
 WS-Discovery Multicast: Enabled
 WS-Print: Enabled
 WS-Scan: Enabled

Web Services
 Copy Submission: Enabled
 Digital Certificate Management and Securi... Enabled
 Extensible Service Registration: Enabled
 Job Limits: Enabled
 Job Management Extension: Enabled
 Device Configuration: Enabled
 Scan Submission: Enabled
 Scan Workflow Management: Enabled
 Session Data: Enabled
 User Interface Configuration: Enabled
 EIP Proxy Configuration: Enabled
 Xerox Secure Access: Disabled
 EIP SNMP Configuration: Enabled
 Print Submission: Enabled
 Scan Template Mgmt: Enabled
 Mass Storage Access: Enabled
 Card Reader Access: Enabled
 Authentication & Accounting Configur... Enabled
 Export Audit Log: Enabled
 Trellix Embedded Control: Enabled

Apps

Printing
 Banner Sheet: Disabled
 Sys/Start Job: Disabled
 Delete Held Jobs After: 3 Day(s) 0 Hour(s) 0 Minute(s)
 Error Sheets: Enabled
 Paper Substitution: Enabled
 Tray Priority: 1,5
 Default Copies: 1
 Default Job Type: Normal Print
 Default Paper Size: x=8.50 inches, y=11.00 inches
 Default Paper Color: White
 Default 2 Sided Printing: 1 Sided
 Default Output Tray: Center Tray
 Default Output Color: Color
 Default Colated Sets: Enabled
 Default Stapling: Not Available
 Offsetting Between Jobs: No Offset Between Jobs
 Archival Marking Mode: Off
 PostScript: Installed
 Level: 3
 Version: 3021 101
 Image Quality: Enhanced

PCL
 Version: 6
 Pitch Size: 10.00
 Point Size: 12.00
 Font Name: Courier
 Lines Per Page: 60
 Custom Color Tables: Enabled
 Label: Not Installed

Fax:
 Not Present
 Fax Line1:
 Fax Line2:

Server Fax:
 Enabled
 Confirmation Sheet: Errors Only
 Delay Start: Disabled
 Repository Protocol: FTP
 Repository Server: 0.0.0.0
 Repository Document Path:

Workflow Scanning:
 Enabled
 Confirmation Sheet: Errors Only
 Default Repository Protocol: FTP
 Default Repository Server: 0.0.0.0
 Default Repository Document Path:
 Default Repository Login Credentials: Device
 Alt1 Repository Protocol: FTP
 Alt1 Repository Server: 0.0.0.0
 Alt1 Repository Document Path:
 Alt1 Repository Login Credentials: Device
 Workflow Pool Protocol: FTP
 Workflow Pool Server: 0.0.0.0
 Workflow Pool Path:

Email:
 Enabled
 Default From Address:
 Confirmation Sheet: Errors Only
 Auto Send to Self: Disabled
 E-mail Security: Disabled

Scan to Mailbox:
 Enabled/Displayed
 View Mailboxes by Default: Enabled
 Storage Capacity (MB): 672 MB
 Storage Used (MB): 49 MB
 Cleanup of Public Folders: Enabled
 Cleanup of Created Folders: Enabled
 Cleanup Time: Daily
 Disabled

Scan to Home:
 Disabled
 Friendly Name:
 Workflow Name:
 Auto Create Subdir: Disabled
 Append User Name to Path: Disabled
 Auto Create User Name Dir: Disabled

Scan To:
 Enabled
 Cloud Services: Disabled

Print From:
 Enabled
 Saved Jobs for Reprint: Enabled
 Print From USB: Enabled
 Print From MailBox: Disabled
 Cloud Services: Disabled

Accounting

Accounting Mode: None
 Network Accounting: Disabled

Security**Authentication Configuration**

Machine UI Authentication: Locally on the Device
 Home: Unlocked
 Jobs: Unlocked
 Device: Unlocked
 Device Website Authentication: Locally on the Device
 Authorization: Locally on the Device
 Retrieve E-mail from LDAP: Enabled

Authentication Server:

Kerberos Kerberos Primary Address: 0.0.0.0:88
 Kerberos Alt 1 Realm: 0.0.0.0:88
 SMB NT Domain:
 SMB Alt 1 NT Domain:
 Smartcard Ctrl Server: 0.0.0.0:443
 Smartcard Ctrl Domain:
 SmartCard OCSP URL:
 Card Reader Upgrade Policy: Enabled
 Card Reader Firmware Version:

Xerox Secure Access:

Secure Access Server: Disabled
 Secure Access Path: 0.0.0.0:443

Audit Log:

Audit Log: Enabled

IP Sec:

IP Sec: Disabled

IP Filtering:

IP Filtering: Disabled

Security Certificates

Machine Certificate: Signed

Root Certificates Installed: 56

802.1x:

802.1x: Disabled

Job Data Removal:

Scheduled: Disabled

Scheduled Frequency: Monthly

FIPS 140-3:

FIPS 140-3: Disabled

TLS:

TLS: TLS 1.1 and TLS 1.2

TLS Hash: SHA-1, SHA-256 and above

Trellix Embedded Control:

Trellix Embedded Control: Disabled

Extensible Service Setup

Third Generation Browser: X3G_3.24.23_2.40.5_012_01.00.00

Widget Version: v1.3.17 c8 20140613

Widget Version: v2.5.04 g9 20240123

Billing Summary

System Information

Machine Name: Xerox VersaLink C415 Color MFP (46:2...
Machine Serial Number: YCQ293082
Power On Impressions: 50

Software Versions
Device Software: 122.028.004.32300
Patch Version: None
Network Controller: 122.028.32300
UI Panel Firmware: 6.2
Marking Engine: 230.314
Document Feeder: 230.314
Finisher: 000.000.000
Fax: 000.000.000
Scanner: 230.314

Billing Meters

Fax

Embedded Fax Images Sent: 0
Embedded Fax Impressions: 0

Copy

Black Copied Impressions: 167
Color Copied Impressions: 721

Print

Black Printed Impressions: 537
Color Printed Impressions: 2651

Scan

Network Scanning Images Sent: 438
E-mail Images Sent: 4

Plain Paper: 3560
Bond: 1
Preprinted: 1
Letterhead: 1
Labels: 1

Device Totals

Black Impressions: 774
Color Impressions: 3372
Total Impressions: 4146

Control Panel

Available apps can vary based on your printer setup. For details about apps and features, refer to the *User Guide*.

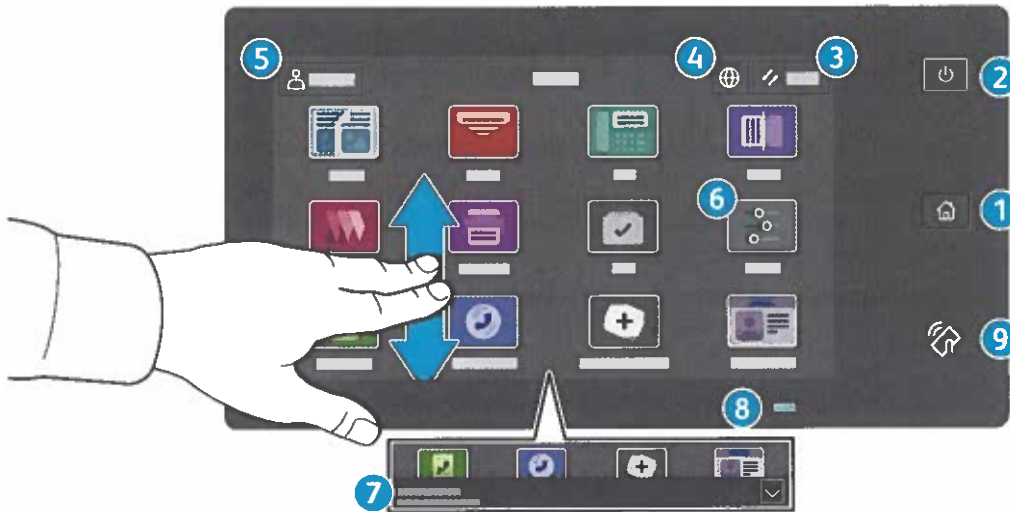

- 1 Home** returns to the main app screen.
- 2 Power/Wake** starts the printer or provides options to sleep, restart or power off the printer.
- 3 Reset** restores settings to their default values in all apps.
- 4 Language** provides choice of screen languages.
- 5 Log In** provides special access to tools and settings.
- 6 Device app** provides access to printer information and settings.
- 7 Notification banner** shows printer status and warnings. To see all notifications, touch the banner. To close the banner, touch the down arrow.
- 8 Status LED** indicates printer status. For detailed information, refer to the *User Guide*.
- 9 NFC Area** allows pairing with a mobile device to print or scan from an app.

Device app

The Device app provides access to supplies status, printer information, and settings. Some menus and settings require log in with the administrator name and password.

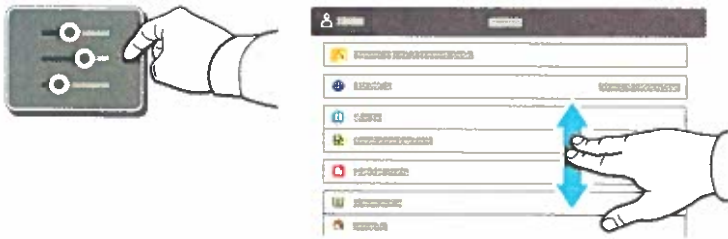

Billing and Usage Information

In the Device features menu, to view basic impression counts, touch **Billing/Usage**. To view detailed usage counts, touch **Usage Counters**. The list provides detailed impression count categories.

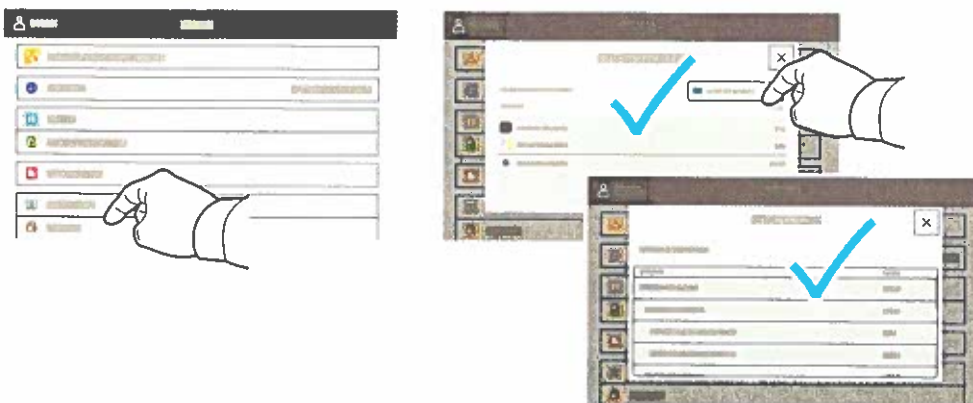

Embedded Web Server

The Xerox® Embedded Web Server enables you to access printer configuration details, paper and supplies status, job status, and diagnostic functions over a network. You can also manage fax, email, and address books.

To connect, in a Web browser, type the printer IP address. The network IPv4 address is available on the control panel touch screen. Touch **Device** app > **About**, then scroll down.

For details on using the Embedded Web Server, refer to the *User Guide* located on Xerox.com.

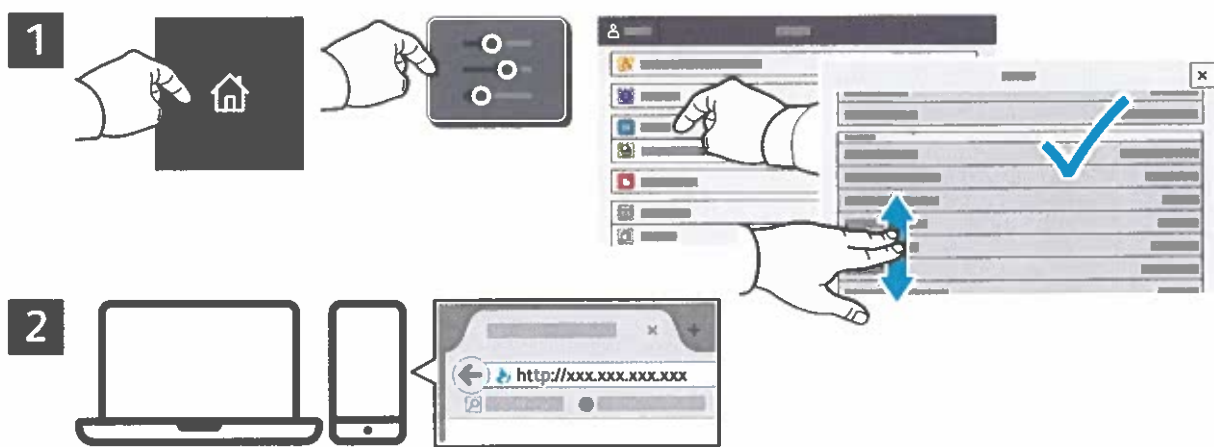

App Gallery

The Xerox App Gallery has a growing collection of productivity apps that you can install on your printer. Find the app on your home screen and create your login directly, or go to www.xerox.com/appgallery to log in and add your device. To simplify app installation, use the same name for your app gallery login credentials that you used for the printer login.

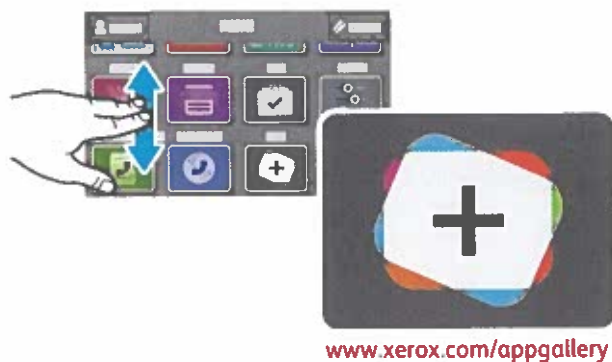

www.xerox.com/appgallery

Printer Tour

Optional accessories can be part of your printer setup. For details, refer to the *User Guide*.

Single-Pass Duplex Automatic Document Feeder (DADF)

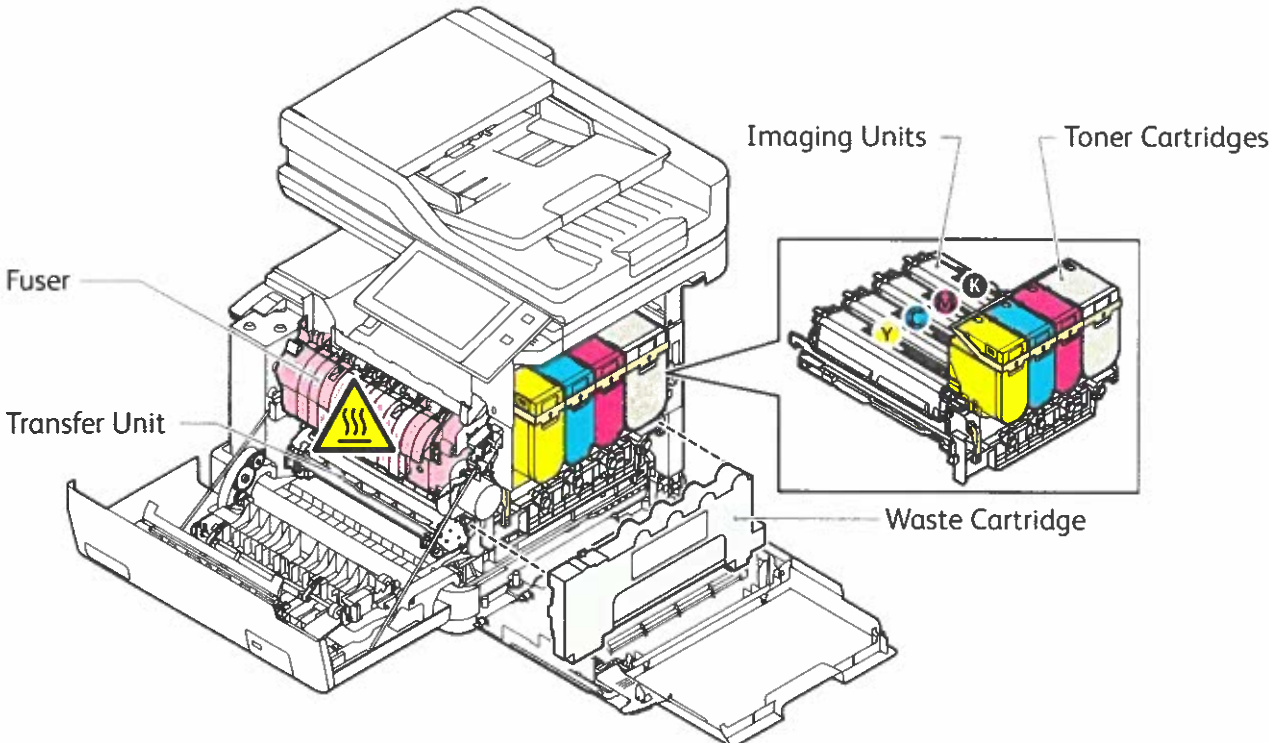
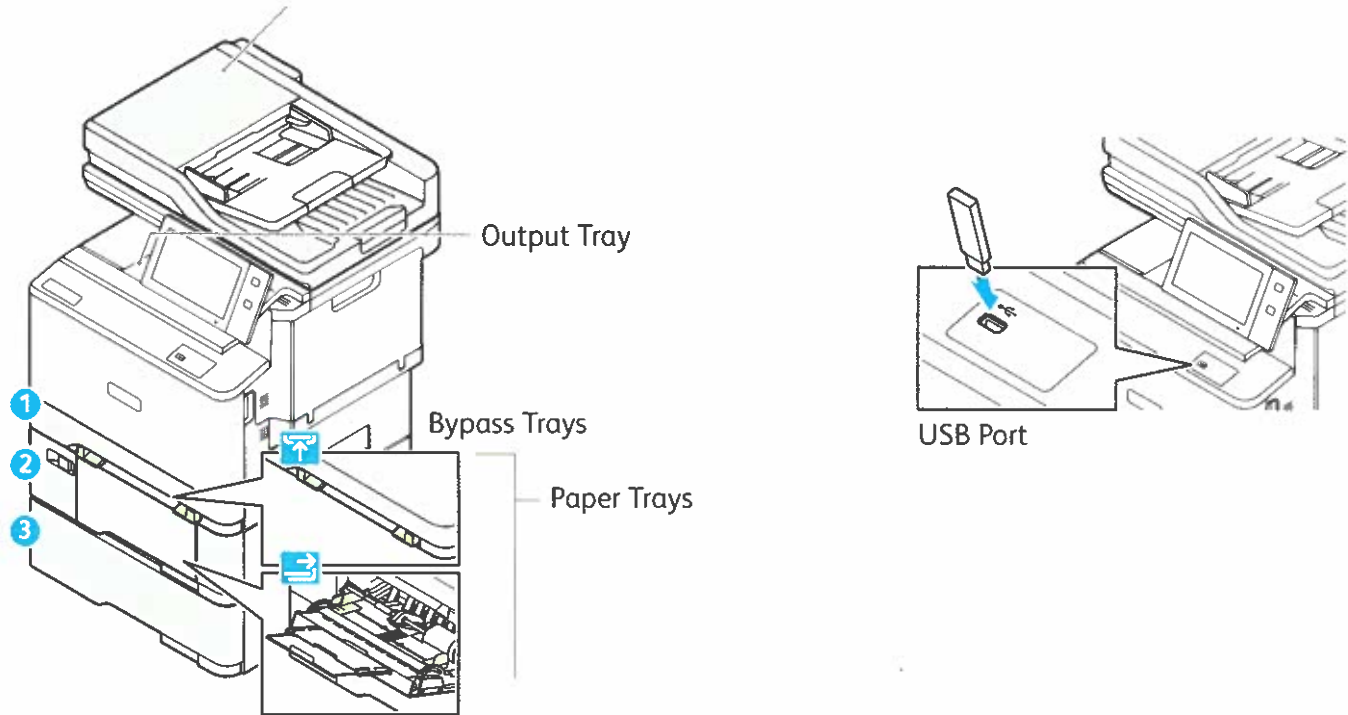

Paper Handling

For a complete list of paper that works with your printer, see the Recommended Media List at:

www.xerox.com/rmlna (U. S. and Canada)

www.xerox.com/rmleu (Europe)

For details about trays and paper, refer to the *User Guide*.

Loading Paper

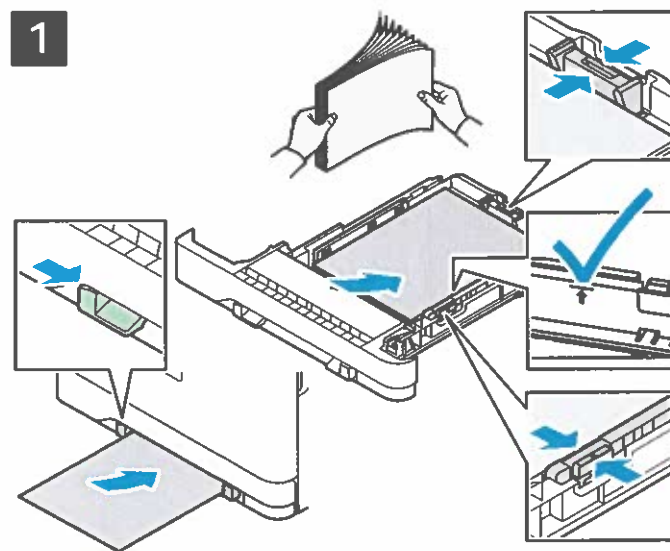

Confirm or change size, type, and color settings if needed.



For the best results, fan the edges of the paper. Adjust the guides to fit the paper size. Do not load paper above the maximum fill line.

When printing, select options in the print driver.

Paper Orientation

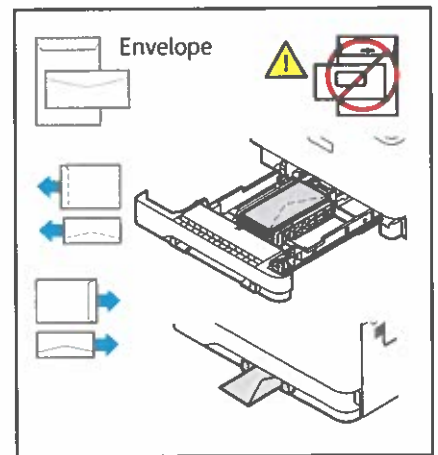
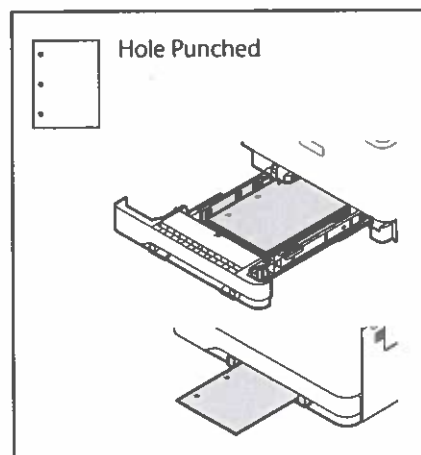
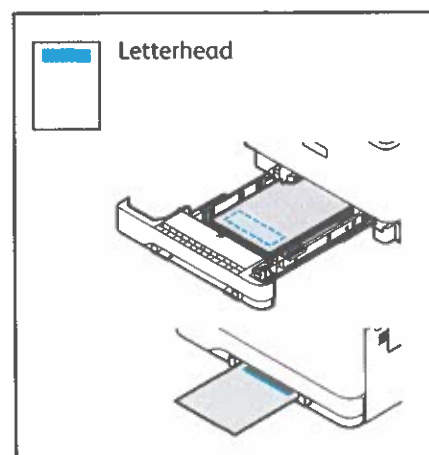

Copying

For details, refer to the *User Guide*.

1

X: 148–356 mm (5.8–14 in.)
Y: 105–216 mm (4.1–8.5 in.)

52–120 g/m²
(14 lb. Text–32 lb. Bond)

≤100 (75 g/m², 20 lb. Bond)

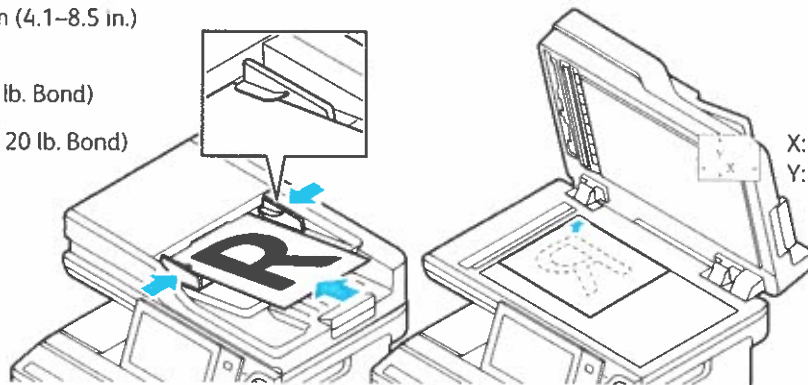

X: 25–356 mm (1–14 in.)
Y: 25–216 mm (1–8.5 in.)

Load the original documents.

2



Touch **Copy**, then and select the number of copies.

3



Select feature settings from the list, then touch **Start**.

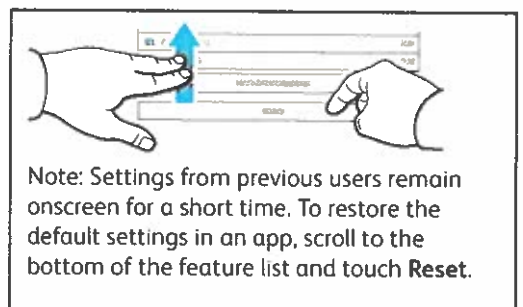

Scanning and Emailing

If the printer is connected to a network, you can select a destination for the scanned image at the printer control panel.

This guide defines techniques to scan documents without preparing special setups:

- Scanning documents to an email address.
- Scanning documents to a saved Favorite, Address Book listing, or USB Flash Drive.
- Scanning documents to the Default Public folder on the printer hard drive, and retrieving them using your Web browser.

For details and more scan setups, refer to the *User Guide*. For details about address book and workflow template setup, refer to the *System Administrator Guide*.

1

 X: 148–356 mm (5.8–14 in.)
Y: 105–216 mm (4.1–8.5 in.)

 52–120 g/m²
(14 lb. Text–32 lb. Bond)

 ≤100 (75 g/m², 20 lb. Bond)

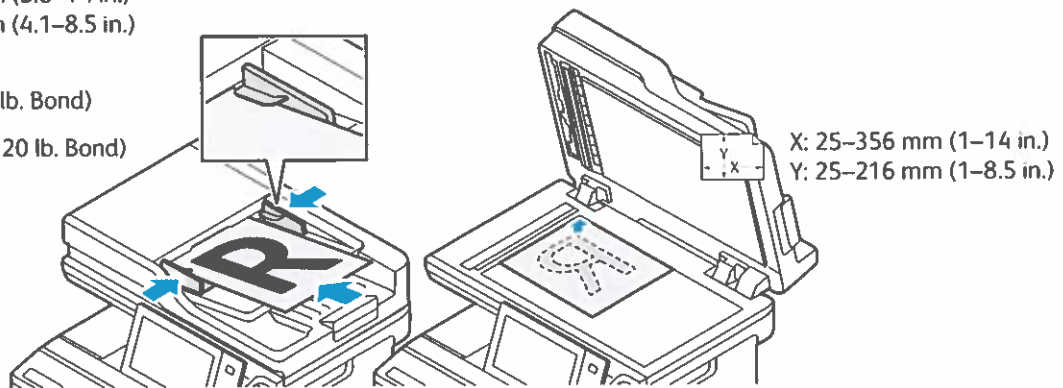

Load the original documents.

2

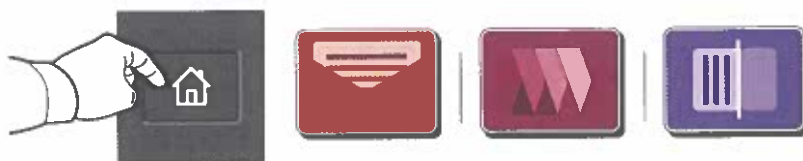

Press **Home**, then to email the scan, touch **Email**. To scan to the Default Public Folder or a USB Flash Drive, touch **Workflow Scanning**. If your scan destination is stored in the Address Book or saved as a Favorite, touch **Scan To**.

3



For Email, touch **Manual Entry**, type the email address using the touch screen keypad, then touch **Add**. To add more than one email address to the list, touch **Add Recipient**. To type a subject line for the email, touch **Subject**. To select saved email addresses, use the Device Address Book or select from Favorites.



For Workflow Scanning, touch **Default Public Folder**, or insert your USB Flash Drive.

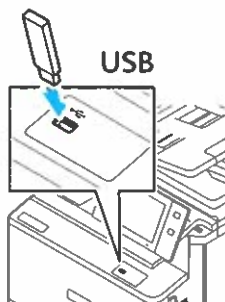

For Scan To, touch a destination type, then enter the appropriate information. To add more than one destination to the list, touch **Add Destination**.

4



Change the settings as needed, then touch **Scan**, or for Email, touch **Send**.

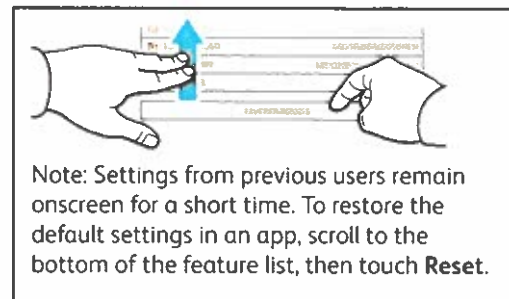

Note: Settings from previous users remain onscreen for a short time. To restore the default settings in an app, scroll to the bottom of the feature list, then touch **Reset**.

Retrieving Scan Files

To download your scanned images from the Default Public Folder on the printer, use the Embedded Web Server. You can set up personal folders and workflow scanning templates in the Embedded Web Server. For details, refer to the *User Guide*.



Note the printer IP address on the touch screen. If the IP Address does not appear in the top of the touch screen, press Home, touch **Device** > **About** then scroll to check the IP Address.

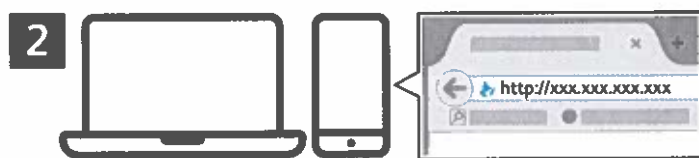

In a Web browser, type the printer IP address, then press **Enter** or **Return**.



Click the **Scan** tab.

4



Select the **Default Public Folder**, then find your scan in the list. To download the scan, click **Go**.

To refresh the list, click **Update View**.

To save the file to your computer, select **Download**.

To print the saved file again, select **Reprint**.

To permanently remove the stored job, select **Delete**.

To open a directory, select **Open**.

Faxing

You can send a fax in one of four ways:

- **Fax** scans the document then sends it directly to a fax machine.
- **Server Fax** scans the document then sends it to a fax server, which transmits the document to a fax machine.
- **Internet Fax** scans the document then emails it to a recipient.
- **LAN Fax** sends the current print job as a fax.

For details, refer to the *User Guide*. For details about LAN Fax, refer to the print driver software. For details about fax setup and advanced settings, refer to the *System Administrator Guide*.

1

 X: 148–356 mm (5.8–14 in.)
Y: 105–216 mm (4.1–8.5 in.)

 52–120 g/m²
(14 lb. Text–32 lb. Bond)

 ≤100 (75 g/m², 20 lb. Bond)

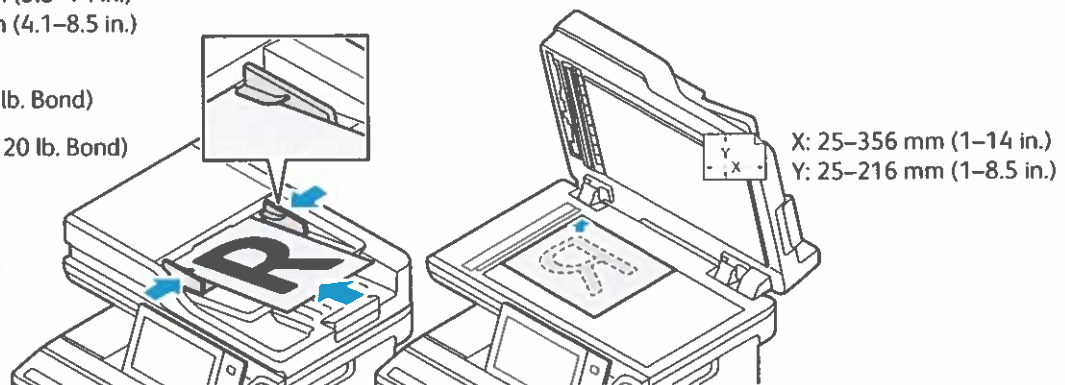

Load the original documents.

2



To send the fax to a fax machine, press **Home**, then touch **Fax** or **Server Fax**.

To send the fax as an email attachment, touch **Home**, then touch **Internet Fax**.



For fax numbers, touch **Manual Entry**, then enter the fax number using the touch screen alphanumeric keys and special characters. Touch **Add**. To add more fax numbers to the list, touch **Add Recipient**.

For Internet Fax email addresses, touch **Manual Entry**, then enter the email address using the touch screen keypad. Touch **Add**. To add more email addresses to the list, touch **Add Recipient**.

To select saved numbers, use the Device Address Book or Favorites. To select stored fax locations, use the Mailbox or Polling.

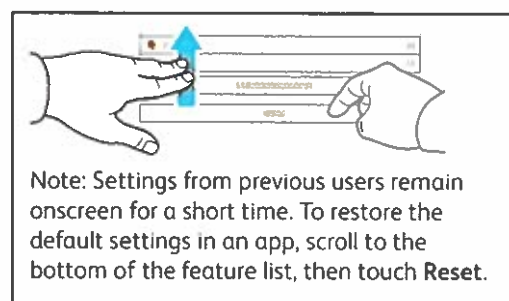
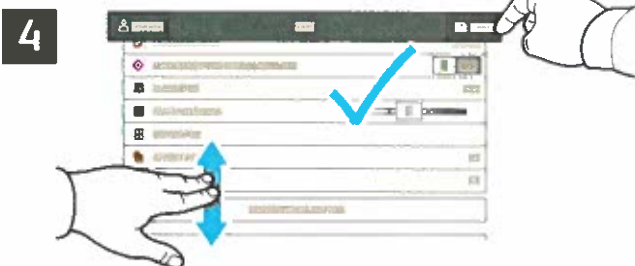

Change the settings as needed, then touch **Send**.

Printing from a USB Flash Drive

You can print .pdf, .tiff, .ps, .xps and other files types directly from a USB Flash Drive. For more information, refer to the *User Guide*.

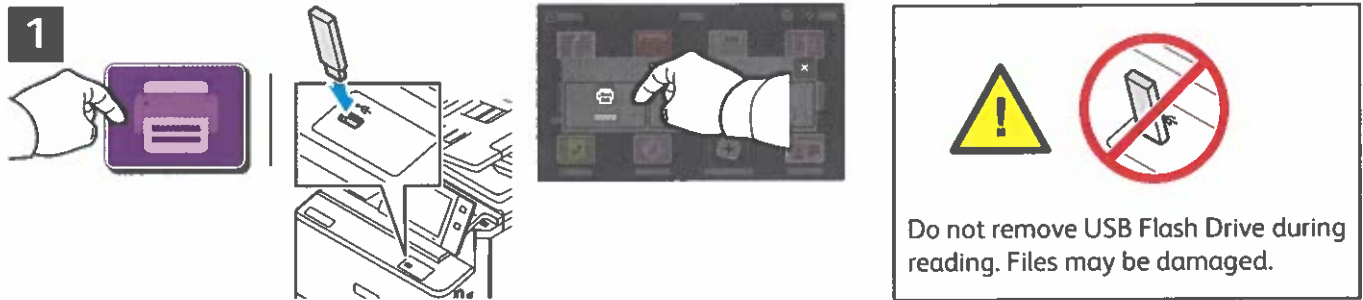

Touch **Print From** or insert your USB Flash Drive, then choose **Print From USB**.

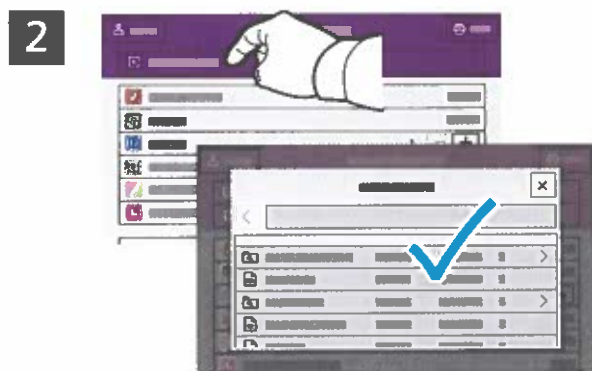

Touch **Add Document**, then navigate to your files and select them.



To select the number of copies, touch the plus sign (+) or the minus sign (-). For larger numbers, touch **Quantity** then enter a number.



Select settings as needed, then touch **Print**.

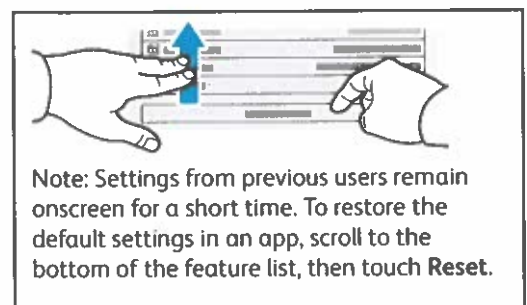

Printing Jobs Stored on the Printer



You can send a print job to save to the printer, then select the job from the printer control panel to print at a later time. Jobs can be saved in the public folder or be password protected. In the Xerox® printer driver, select **Properties** (Windows) or **Xerox Features** (Mac OS), then **Job Type**. Select **Saved Job** or **Secure Print**. For Secure Print, type a passcode. Click **OK** and print the job.

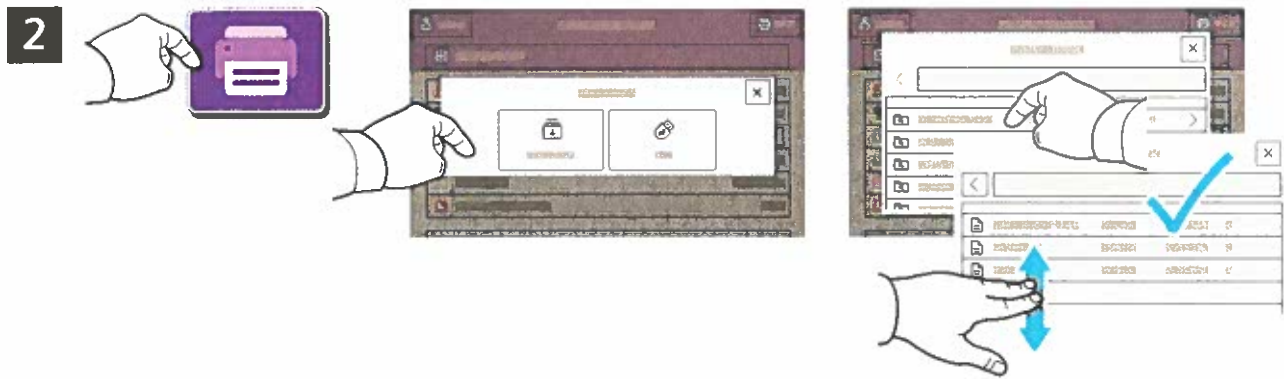

Touch **Print From** then touch **Saved Jobs**. Select the **Default Public Folder** then select your print job.

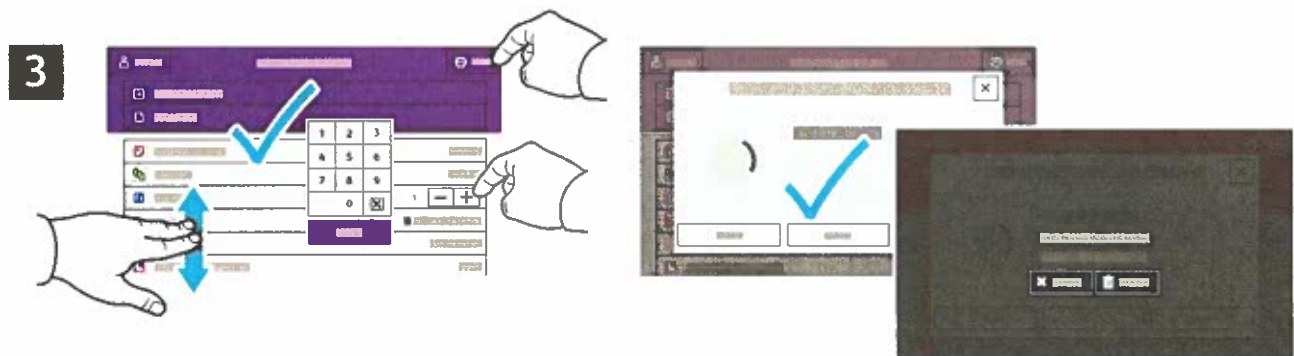

Select settings from the list. To select the number of copies, touch the plus sign (+) or the minus sign (-). For larger numbers, touch **Quantity** then enter a number. Touch **Print**. To delete the job, in the printing screen and confirmation screen, touch **Delete**.

Troubleshooting Print Quality

Your Xerox® VersaLink® C415 Color Multifunction Printer is designed to produce high-quality color prints consistently. If you observe print-quality problems, use the information on these pages to troubleshoot the problems. For detailed online support information, go to www.xerox.com/office/support.

CAUTION: The Xerox® warranty, Service Agreement, or Total Satisfaction Guarantee does not cover damage caused by using unsupported paper, transparencies, or other specialty media. The Total Satisfaction Guarantee is available in the United States and Canada. Coverage can vary outside of these areas. For details, contact your local representative.

Paper Type

CAUTION: If you change the type of paper in the tray, change the paper type at the control panel to match the paper in the tray. If you fail to change the paper type, it can cause print-quality problems and damage the fuser.

For the best results, only use recommended Xerox® paper and media. Xerox® paper and media are guaranteed to produce excellent results on your Xerox® VersaLink® C415 Color Multifunction Printer. To order Xerox® paper and media, go to www.xerox.com/office/supplies.

For a complete list of recommended paper for your printer, go to:

- North America: www.xerox.com/rmlna
- Europe: www.xerox.com/rmleu



Solving Print-Quality Problems

Use the following tables to find specific solutions to print-quality problems.

Solving Print-Quality Problems

Problem	Solution
<p data-bbox="102 396 304 423">Incomplete Fusing</p> <p data-bbox="102 432 580 490">Toner appears to be missing from the print, or rubs off easily.</p> 	<ol data-bbox="644 396 1390 678" style="list-style-type: none">1. Verify that the paper you are using is the correct type for the printer and is properly loaded. For a complete list of recommended paper for your printer, go to:<ul data-bbox="676 499 1358 568" style="list-style-type: none">– North America: www.xerox.com/rmlna– Europe: www.xerox.com/rmleu2. Verify that the paper type is selected on the control panel and in the print driver.3. If the problem persists, do one of the following: <p data-bbox="676 689 1382 748">Note: To change the size, type, or color of paper in a dedicated tray when the control panel is locked, log in as the system administrator.</p> <ol data-bbox="676 759 1414 1106" style="list-style-type: none">a. For trays that are set to Dedicated:<ul data-bbox="715 797 1414 987" style="list-style-type: none">• At the control panel, touch Log In. Enter system administrator login information, then touch Enter. For details, refer to the <i>System Administrator Guide</i>.• Touch Device > Tools > Device Settings > Paper Management > Tray Settings. Select the tray, touch Edit, then change the paper type.b. For trays that are set to Fully Adjustable:<ul data-bbox="715 1039 1315 1106" style="list-style-type: none">• Paper Trays: Open, then close the selected paper tray.• Bypass Tray: Remove, then reinsert the paper. <p data-bbox="676 1117 1390 1144">The control panel prompts you to confirm or change the paper type.</p> <ol data-bbox="715 1155 1414 1263" style="list-style-type: none">• At the touch screen, touch Type, then do one of the following:<ul data-bbox="759 1196 1331 1263" style="list-style-type: none">• Select the correct paper type, then touch Confirm.• Select the next heavier type of paper, then touch Confirm. <p data-bbox="676 1274 1171 1301">Note: Paper types from lightest to heaviest are:</p> <ul data-bbox="715 1312 1382 1438" style="list-style-type: none">• For uncoated paper: Plain, Lightweight Cardstock, and Cardstock.• For coated paper: Lightweight Glossy Cardstock and Glossy Cardstock.



Solving Print-Quality Problems (continued)

Problem	Solution
<p data-bbox="102 405 304 432">Repeating Defects</p> <p data-bbox="102 443 555 555">Spots or lines appear at regular intervals on the page in the direction that the paper moves through the printer in all colors or in non-printed areas.</p>  <p data-bbox="102 869 555 954">Spots or lines appear at regular intervals on the page, in the direction the paper moves through the printer, and in one color only.</p> 	<ol data-bbox="647 405 1374 595" style="list-style-type: none">1. At the control panel, touch Device > Tools > Troubleshooting > Support Pages > Repeating Defects Page > Print. The Repeating Defects Page prints with instructions for identifying defective units.2. To correct the problem, replace items identified on the Repeating Defects Page.  <ol data-bbox="647 936 1417 1290" style="list-style-type: none">3. If you replace a supply, reset the counter:<ol data-bbox="679 976 1417 1290" style="list-style-type: none">a. At the control panel, touch Log In. Enter system administrator login information, then touch Enter. For details, refer to the <i>System Administrator Guide</i>.b. Touch Device > Tools > Device Settings.c. Scroll, then touch Supplies > Supply Counter Reset.d. Touch the replaced Supply.e. Touch Reset Counter.f. To close the pop-up window, touch X, touch admin, then select Log Out.

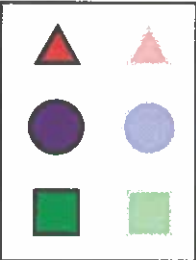
Solving Print-Quality Problems (continued)

Problem	Solution
<p>Offset Image</p> <p>The most common offset is toner that appears to be reprinted on the page and placed about 95 mm (3.75 in.) across the page in the direction that the paper moves through the printer.</p> <p>Note: For a different distance, use the Repeating Defects Page to identify the cause.</p> 	<ol style="list-style-type: none">1. Verify that the paper you are using is the correct paper type for the printer and is properly loaded. For a complete list of recommended paper for your printer, go to:<ul style="list-style-type: none">– North America: www.xerox.com/rmlna– Europe: www.xerox.com/rmleu2. Verify that the paper type is selected on the control panel and in the print driver. Note: To change the size, type, or color of paper in a dedicated tray when the control panel is locked, log in as the system administrator.3. If the problem persists, do one of the following: Note: To change the size, type, or color of paper in a dedicated tray when the control panel is locked, log in as the system administrator.<ol style="list-style-type: none">a. For trays that are set to Dedicated:<ul style="list-style-type: none">• At the control panel, touch Log In. Enter system administrator login information, then touch Enter. For details, refer to the <i>System Administrator Guide</i>.• Touch Device > Tools > Device Settings > Paper Management > Tray Settings. Select the tray, touch Edit, then change the paper type.b. For trays that are set to Fully Adjustable:<ul style="list-style-type: none">• Paper Trays: Open, then close the selected paper tray.• Bypass Tray: Remove, then reinsert the paper.The control panel prompts you to confirm or change the paper type.<ul style="list-style-type: none">• At the touch screen, touch Type, then do one of the following:<ul style="list-style-type: none">• Select the correct paper type, then touch Confirm.• Select the next heavier type of paper, then touch Confirm.Note: Paper types from lightest to heaviest are:<ul style="list-style-type: none">• For uncoated paper: Plain, Lightweight Cardstock, and Cardstock.• For coated paper: Lightweight Glossy Cardstock and Glossy Cardstock.4. To identify the cause, use the Repeating Defects Page. For details, refer to the previous page.

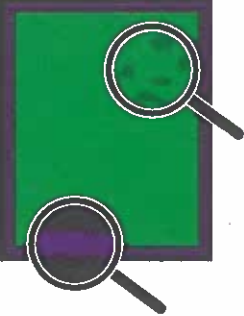
Solving Print-Quality Problems (continued)

Problem	Solution
<p>Heavy Coverage Appears Mottled or Blotchy Blacks Appear Blue</p> 	<ol style="list-style-type: none">1. Verify that the paper you are using is the correct type for the printer and is properly loaded. For a complete list of recommended paper for your printer, go to:<ul style="list-style-type: none">– North America: www.xerox.com/rmlna– Europe: www.xerox.com/rmleu2. Verify that the paper type is selected on the control panel and in the print driver. <p>Note: If the problem continues, call for service.</p>
<p>Colors Align Incorrectly Color has shifted outside the designated area or is superimposed over another color.</p> 	<p>Open, then close the front door. The printer performs an automatic registration calibration with the next print.</p> <p>Note: If the problem continues, call for service.</p>
<p>All Colors Too Light or Too Dark Colors appear faded or too dark on print or copy.</p>	<ol style="list-style-type: none">1. Verify that the paper you are using is the correct type for the printer and is properly loaded. For a complete list of recommended paper for your printer, go to:<ul style="list-style-type: none">– North America: www.xerox.com/rmlna– Europe: www.xerox.com/rmleu2. Verify that the paper type is selected on the control panel and in the print driver. <p>Note: If the problem continues, refer to <i>User Guide</i> or call for service.</p>

Solving Print-Quality Problems (continued)

Problem	Solution
<p>Lines, Smudges, or Streaks Dark or light marks appear on the page in all colors and/or in non-printed areas.</p> 	<ol style="list-style-type: none"> 1. Verify that the paper you are using is the correct type for the printer and is properly loaded. For a complete list of recommended paper for your printer, go to: <ul style="list-style-type: none"> – North America: www.xerox.com/rmlna – Europe: www.xerox.com/rmleu 2. Verify that the paper type is selected on the control panel and in the print driver. 3. To identify the cause, refer to the Repeating Defects Page that prints with <i>Troubleshooting Print Quality Page</i>. At the control panel, touch Device > Tools > Troubleshooting > Support Pages > Repeating Defects Page > Print. 4. To correct the problem, replace items identified on the Repeating Defects Page.
<p>Colors Vary Between Computers The colors printed from one computer do not match the colors printed from a different computer.</p>	<ol style="list-style-type: none"> 1. Confirm that the print driver settings for Print Quality, Color Correction, and Color By Words are identical on both computers. 2. Adjust the settings as needed. <p>Note: Print driver settings override the settings that are made at the printer control panel.</p>
<p>Colors Do Not Match The color produced by the printer is different from the color that it must match.</p>	<p>For more information about color matching, go to the Online Support Assistant at www.xerox.com/office/support.</p>
<p>Printed Colors Do Not Match Monitor Colors The color produced by the printer looks different from the color that appears on the computer monitor.</p>	<p>To view information about color matching between the monitor and the printed document, go to the Online Support Assistant at www.xerox.com/office/support.</p>

Print-Quality Settings

The Print-Quality mode and Color Corrections options directly control the quality of your prints. You can change these settings in the print driver. Select the setting that is best suited for your print job.

Print-Quality Mode

- **Enhanced mode** is the general-purpose mode for crisp, bright color prints. Enhanced mode balances speed with quality.
- **High Resolution mode** is a high-quality mode that creates fine lines and detail. High Resolution mode is recommended for vibrant, saturated color prints. High Resolution mode balances quality over speed.

Color Corrections

Color corrections are available on the Image Options tab in the print driver. The Preview window appears on the right side of the Image Options tab. When the Preview check box is selected, color correction appear in the Preview window. Selecting and clearing the Preview check box allows you to compare the corrected image to the uncorrected image.

To adjust the color characteristics of your print job, select the Color Correction tab, then select options as needed.

- **Xerox Black and White** converts the colors to grayscale, producing a black and white print job. This setting is useful for creating black and white master documents for photocopying or faxing.
- **Color Correction** provides options to match the printer colors as closely as possible to colors on other devices, such as your computer screen or a printing press.
 - **Xerox Automatic Color** applies the best color correction to each graphic element of the document: text, artwork, and photographs.
 - **Vivid RGB** produces the brightest, most saturated colors.
 - **None** removes all color correction. This option is the best choice when working with color specified within your application or operating system.

To change settings for each individual color parameter, select the **Color Adjustments** tab, then adjust the sliders. The sliders allow you to select a continuous range of adjustment for each of the following:

- Lightness
- Contrast
- Saturation
- Cyan to Red
- Magenta to Green
- Yellow to Blue

For more information on color matching and ICC profiles, go to www.xerox.com/office/support.

Supplies Usage

Consumables

Toner Cartridges



Black

Date Installed: Dec 8, 2023
 Reorder: 006R04685
 Estimated Pages Remaining: 9000
 (Based upon this toner cartridge's average coverage: 6%)

Life Remaining: 100%
 50%
 0%

Cyan

Date Installed: Sep 6, 2024
 Reorder: 006R04694
 Estimated Pages Remaining: 10000
 (Based upon this toner cartridge's average coverage: 16%)

Life Remaining: 100%
 50%
 0%

Magenta

Date Installed: Jul 18, 2024
 Reorder: 006R04715
 Estimated Pages Remaining: 4000
 (Based upon this toner cartridge's average coverage: 11%)

Life Remaining: 100%
 50%
 0%

Yellow

Date Installed: Oct 10, 2023
 Reorder:
 Estimated Pages Remaining: 6000
 (Based upon this toner cartridge's average coverage: 11%)

Life Remaining: 100%
 50%
 0%

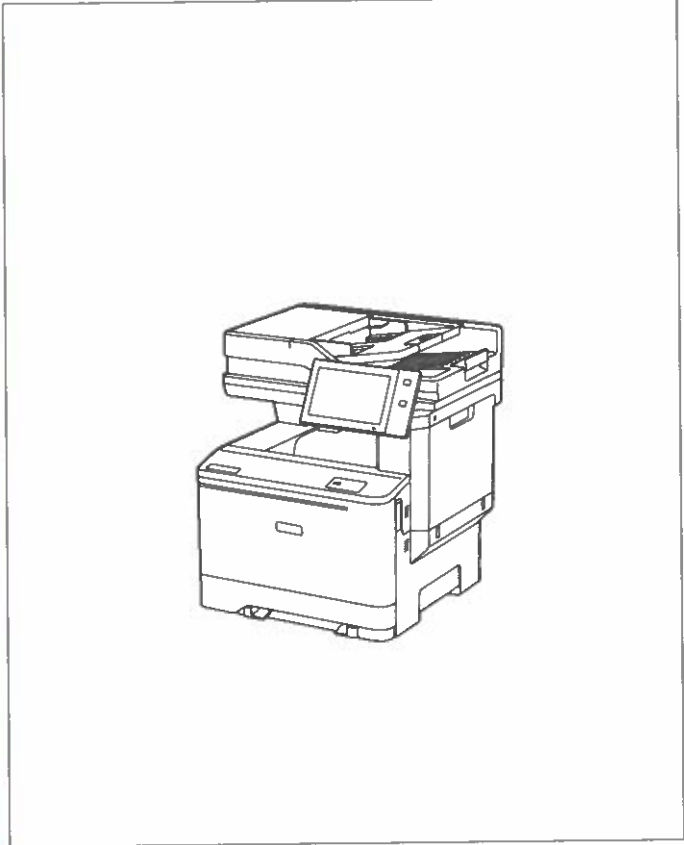

Routine Maintenance Items

Imaging Kit

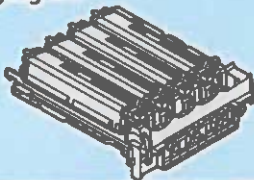

Imaging Kit

Date Installed: Jul 18, 2024
 Reorder: 50MPN000
 Estimated Pages Remaining: 125000
 (Based on average printer job size: 1 Pages)

Life Remaining: 100%
 50%
 0%

Waste Container

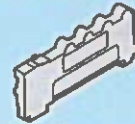

Date Installed: Aug 14, 2024
 Reorder: 008R13335

OK

Xerox® VersaLink® C415 Color Multifunction Printer

Powerful performance. Personalized productivity.

The VersaLink® C415 Color Multifunction Printer provides exceptional performance and unbeatable reliability. Cloud-connected, mobile-ready, app-enabled, and easy to customize, the C415 is your modern workplace assistant — transforming the way you work today, while ensuring you can keep up with the needs of tomorrow.



PRINT, COPY, SCAN, FAX, CLOUD



42 ppm Letter
40 ppm A4



Solutions



Cloud connectivity



Single pass
Two-sided scanning



1200 x 1200 dpi



Up to 1,451 pages



Optional:
Up to 2 additional
paper trays

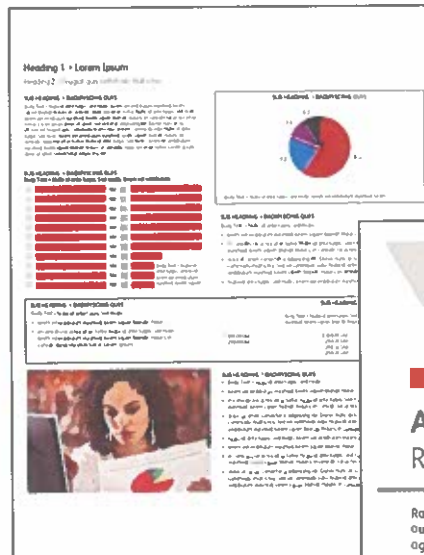

Resident Fonts

Position	Font Name	Print Sample
1	Courier «Esc»(Symbol set«Esc»(s0p«pitch»h0s0b4099T	'ABCDEFGHabcdefgh0123456789&?!.,'
2	CG Times «Esc»(Symbol set«Esc»(s1p«size»v0s0b4101T	'ABCDEFGHabcdefgh0123456789&?!.,'
3	CG Times Bold «Esc»(Symbol set«Esc»(s1p«size»v0s3b4101T	' ABCDEFGHabcdefgh0123456789&?!.,'
4	CG Times Italic «Esc»(Symbol set«Esc»(s1p«size»v1s0b4101T	' <i>ABCDEFGHabcdefgh0123456789&?!.,'</i>
5	CG Times Bold Italic «Esc»(Symbol set«Esc»(s1p«size»v1s3b4101T	' <i>ABCDEFGHabcdefgh0123456789&?!.,'</i>
6	CG Omega «Esc»(Symbol set«Esc»(s1p«size»v0s0b4113T	'ABCDEFGHabcdefgh0123456789&?!.,'
7	CG Omega Bold «Esc»(Symbol set«Esc»(s1p«size»v0s3b4113T	' ABCDEFGHabcdefgh0123456789&?!.,'
8	CG Omega Italic «Esc»(Symbol set«Esc»(s1p«size»v1s0b4113T	' <i>ABCDEFGHabcdefgh0123456789&?!.,'</i>
9	CG Omega Bold Italic «Esc»(Symbol set«Esc»(s1p«size»v1s3b4113T	' <i>ABCDEFGHabcdefgh0123456789&?!.,'</i>
10	Coronet «Esc»(Symbol set«Esc»(s1p«size»v1s0b4116T	' <i>ABCDEF^gghijklm0123456789&?!.,'</i>
11	Clarendon Condensed «Esc»(Symbol set«Esc»(s1p«size»v4s3b4140T	' ABCDEFGHabcdefgh0123456789&?!.,'
12	Univers Medium «Esc»(Symbol set«Esc»(s1p«size»v0s0b4148T	'ABCDEFGHabcdefgh0123456789&?!.,'
13	Univers Bold «Esc»(Symbol set«Esc»(s1p«size»v0s3b4148T	' ABCDEFGHabcdefgh0123456789&?!.,'
14	Univers Medium Italic «Esc»(Symbol set«Esc»(s1p«size»v1s0b4148T	' <i>ABCDEFGHabcdefgh0123456789&?!.,'</i>
15	Univers Bold Italic «Esc»(Symbol set«Esc»(s1p«size»v1s3b4148T	' <i>ABCDEFGHabcdefgh0123456789&?!.,'</i>
16	Univers Medium Condensed «Esc»(Symbol set«Esc»(s1p«size»v4s0b4148T	'ABCDEFGHabcdefgh0123456789&?!.,'
17	Univers Bold Condensed «Esc»(Symbol set«Esc»(s1p«size»v4s3b4148T	' ABCDEFGHabcdefgh0123456789&?!.,'
18	Univers Medium Condensed Italic «Esc»(Symbol set«Esc»(s1p«size»v5s0b4148T	' <i>ABCDEFGHabcdefgh0123456789&?!.,'</i>

Resident Fonts

Position	Font Name	Print Sample
19	Univers Bold Condensed Italic «Esc»(Symbol set«Esc»(s1p«size»v5s3b4148T	'ABCDEFGabcdefg0123456789&?!.,'
20	Antique Olive «Esc»(Symbol set«Esc»(s1p«size»v0s0b4168T	'ABCDEFGabcdefg0123456789&?!.,'
21	Antique Olive Bold «Esc»(Symbol set«Esc»(s1p«size»v0s3b4168T	'ABCDEFGabcdefg0123456789&?!.,'
22	Antique Olive Italic «Esc»(Symbol set«Esc»(s1p«size»v1s0b4168T	'ABCDEFGabcdefg0123456789&?!.,'
23	Garamond Antiqua «Esc»(Symbol set«Esc»(s1p«size»v0s0b4197T	'ABCDEFGabcdefg0123456789&?!.,'
24	Garamond Halbfett «Esc»(Symbol set«Esc»(s1p«size»v0s3b4197T	'ABCDEFGabcdefg0123456789&?!.,'
25	Garamond Kursiv «Esc»(Symbol set«Esc»(s1p«size»v1s0b4197T	'ABCDEFGabcdefg0123456789&?!.,'
26	Garamond Kursiv Halbfett «Esc»(Symbol set«Esc»(s1p«size»v1s3b4197T	'ABCDEFGabcdefg0123456789&?!.,'
27	Marigold «Esc»(Symbol set«Esc»(s1p«size»v0s0b4297T	'ABCDEFGabcdefg0123456789&?!.,'
28	Albertus Medium «Esc»(Symbol set«Esc»(s1p«size»v0s1b4362T	'ABCDEFGabcdefg0123456789&?!.,'
29	Albertus Extra Bold «Esc»(Symbol set«Esc»(s1p«size»v0s4b4362T	'ABCDEFGabcdefg0123456789&?!.,'
30	Ryadh «Esc»(Symbol set«Esc»(s1p«size»v0s0b4859T	ABCDEFGabcdefg0123456789&?!.,'
31	Ryadh Bold «Esc»(Symbol set«Esc»(s1p«size»v0s3b4859T	ABCDEFGabcdefg0123456789&?!.,'
32	Malka «Esc»(Symbol set«Esc»(s1p«size»v0s0b16584T	ABCDEFGabcdefg0123456789&?!.,'
33	Malka Bold «Esc»(Symbol set«Esc»(s1p«size»v0s3b16584T	ABCDEFGabcdefg0123456789&?!.,'
34	Malka Italic «Esc»(Symbol set«Esc»(s1p«size»v1s0b16584T	ABCDEFGabcdefg0123456789&?!.,'
35	Dorit «Esc»(Symbol set«Esc»(s1p«size»v0s0b16585T	ABCDEFGabcdefg0123456789&?!.,'
36	Dorit Bold «Esc»(Symbol set«Esc»(s1p«size»v0s3b16585T	ABCDEFGabcdefg0123456789&?!.,'

Resident Fonts

Position	Font Name	Print Sample
37	Naamit «Esc»(Symbol set«Esc»(s1p«size»v0s0b16587T	ABCDEFGFGabcdefg0123456789&?!.,'
38	Naamit Bold «Esc»(Symbol set«Esc»(s1p«size»v0s3b16587T	ABCDEFGFGabcdefg0123456789&?!.,'
39	Arial «Esc»(Symbol set«Esc»(s1p«size»v0s0b16602T	'ABCDEFGFGabcdefg0123456789&?!.,'
40	Arial Bold «Esc»(Symbol set«Esc»(s1p«size»v0s3b16602T	'ABCDEFGFGabcdefg0123456789&?!.,'
41	Arial Italic «Esc»(Symbol set«Esc»(s1p«size»v1s0b16602T	' <i>ABCDEFGFGabcdefg0123456789&?!.,'</i>
42	Arial Bold Italic «Esc»(Symbol set«Esc»(s1p«size»v1s3b16602T	' <i>ABCDEFGFGabcdefg0123456789&?!.,'</i>
43	Times New Roman «Esc»(Symbol set«Esc»(s1p«size»v0s0b16901T	'ABCDEFGFGabcdefg0123456789&?!.,'
44	Times New Roman Bold «Esc»(Symbol set«Esc»(s1p«size»v0s3b16901T	' ABCDEFGFGabcdefg0123456789&?!.,'
45	Times New Roman Italic «Esc»(Symbol set«Esc»(s1p«size»v1s0b16901T	' <i>ABCDEFGFGabcdefg0123456789&?!.,'</i>
46	Times New Roman Bold Italic «Esc»(Symbol set«Esc»(s1p«size»v1s3b16901T	' <i>ABCDEFGFGabcdefg0123456789&?!.,'</i>
47	Helvetica «Esc»(Symbol set«Esc»(s1p«size»v0s0b24580T	'ABCDEFGFGabcdefg0123456789&?!.,'
48	Helvetica Bold «Esc»(Symbol set«Esc»(s1p«size»v0s3b24580T	' ABCDEFGFGabcdefg0123456789&?!.,'
49	Helvetica Oblique «Esc»(Symbol set«Esc»(s1p«size»v1s0b24580T	' <i>ABCDEFGFGabcdefg0123456789&?!.,'</i>
50	Helvetica Bold Oblique «Esc»(Symbol set«Esc»(s1p«size»v1s3b24580T	' <i>ABCDEFGFGabcdefg0123456789&?!.,'</i>
51	Helvetica Narrow «Esc»(Symbol set«Esc»(s1p«size»v4s0b24580T	'ABCDEFGFGabcdefg0123456789&?!.,'
52	Helvetica Narrow Bold «Esc»(Symbol set«Esc»(s1p«size»v4s3b24580T	' ABCDEFGFGabcdefg0123456789&?!.,'
53	Helvetica Narrow Oblique «Esc»(Symbol set«Esc»(s1p«size»v5s0b24580T	' <i>ABCDEFGFGabcdefg0123456789&?!.,'</i>
54	Helvetica Narrow Bold Oblique «Esc»(Symbol set«Esc»(s1p«size»v5s3b24580T	' <i>ABCDEFGFGabcdefg0123456789&?!.,'</i>

Resident Fonts

Position	Font Name	Print Sample
55	Palatino Roman «Esc»(Symbol set«Esc»(s1p«size»v0s0b24591T	'ABCDEFgabcdefg0123456789&?!.,'
56	Palatino Bold «Esc»(Symbol set«Esc»(s1p«size»v0s3b24591T	'ABCDEFgabcdefg0123456789&?!.,'
57	Palatino Italic «Esc»(Symbol set«Esc»(s1p«size»v1s0b24591T	'ABCDEFgabcdefg0123456789&?!.,'
58	Palatino Bold Italic «Esc»(Symbol set«Esc»(s1p«size»v1s3b24591T	'ABCDEFgabcdefg0123456789&?!.,'
59	ITC Avant Garde Book «Esc»(Symbol set«Esc»(s1p«size»v0s0b24607T	'ABCDEFgabcdefg0123456789&?!.,'
60	ITC Avant Garde DemiBold «Esc»(Symbol set«Esc»(s1p«size»v0s2b24607T	'ABCDEFgabcdefg0123456789&?!.,'
61	ITC Avant Garde Book Oblique «Esc»(Symbol set«Esc»(s1p«size»v1s0b24607T	'ABCDEFgabcdefg0123456789&?!.,'
62	ITC Avant Garde DemiBold Oblique «Esc»(Symbol set«Esc»(s1p«size»v1s2b24607T	'ABCDEFgabcdefg0123456789&?!.,'
63	ITC Bookman Light «Esc»(Symbol set«Esc»(s1p«size»v0s-3b24623T	'ABCDEFgabcdefg0123456789&?!.,'
64	ITC Bookman DemiBold «Esc»(Symbol set«Esc»(s1p«size»v0s2b24623T	'ABCDEFgabcdefg0123456789&?!.,'
65	ITC Bookman Light Italic «Esc»(Symbol set«Esc»(s1p«size»v1s-3b24623T	'ABCDEFgabcdefg0123456789&?!.,'
66	ITC Bookman DemiBold Italic «Esc»(Symbol set«Esc»(s1p«size»v1s2b24623T	'ABCDEFgabcdefg0123456789&?!.,'
67	New Century Schoolbook Roman «Esc»(Symbol set«Esc»(s1p«size»v0s0b24703T	'ABCDEFgabcdefg0123456789&?!.,'
68	New Century Schoolbook Bold «Esc»(Symbol set«Esc»(s1p«size»v0s3b24703T	'ABCDEFgabcdefg0123456789&?!.,'
69	New Century Schoolbook Italic «Esc»(Symbol set«Esc»(s1p«size»v1s0b24703T	'ABCDEFgabcdefg0123456789&?!.,'
70	New Century Schoolbook Bold Ital «Esc»(Symbol set«Esc»(s1p«size»v1s3b24703T	'ABCDEFgabcdefg0123456789&?!.,'
71	Times Roman «Esc»(Symbol set«Esc»(s1p«size»v0s0b25093T	'ABCDEFgabcdefg0123456789&?!.,'
72	Times Roman Bold «Esc»(Symbol set«Esc»(s1p«size»v0s3b25093T	'ABCDEFgabcdefg0123456789&?!.,'

Resident Fonts

Position	Font Name	Print Sample
73	Times Roman Italic «Esc»(Symbol set«Esc»(s1p«size»v1s0b25093T	'ABCDEF <i>G</i> abcde <i>fg</i> 0123456789&?!.,'
74	Times Bold Italic «Esc»(Symbol set«Esc»(s1p«size»v1s3b25093T	'ABCDEF <i>G</i> abcde <i>fg</i> 0123456789&?!.,'
75	Zapf Chancery Medium Italic «Esc»(Symbol set«Esc»(s1p«size»v1s0b45099T	'ABCDEF <i>G</i> abcde <i>fg</i> 0123456789&?!.,'
76	Symbol «Esc»(19M«Esc»(s1p«size»v0s0b16686T	(αβχδεφγηιφκλμνοπθρστυωξψζθς)
77	Symbol PS «Esc»(19M«Esc»(s1p«size»v0s0b45358T	(αβχδεφγηιφκλμνοπθρστυωξψζθς)
78	Wingdings «Esc»(579L«Esc»(s1p«size»v0s0b31402T	☞ ▲ ◆ ⚡ ✓ ☑ ☒ ☓ ☔ ☕ ☖ ☗ ☘ ☙ ☚ ☛ ☜ ☝ ☞ ☟ ☠ ☡ ☢ ☣ ☤ ☥ ☦ ☧ ☨ ☩ ☪ ☫ ☬ ☭ ☮ ☯ ☰ ☱ ☲ ☳ ☴ ☵ ☶ ☷ ☸ ☹ ☺ ☻ ☼ ☽ ☾ ☿ ☽
79	Zapf Dingbats «Esc»(14L«Esc»(s1p«size»v0s0b45101T	⊛ ⊜ ⊝ ⊞ ⊟ ⊠ ⊡ ⊢ ⊣ ⊤ ⊥ ⊦ ⊧ ⊨ ⊩ ⊪ ⊫ ⊬ ⊭ ⊮ ⊯ ⊰ ⊱ ⊲ ⊳ ⊴ ⊵ ⊶ ⊷ ⊸ ⊹ ⊺ ⊻ ⊼ ⊽ ⊾ ⊿
80	Courier Bold «Esc»(Symbol set«Esc»(s0p«pitch»h0s3b4099T	'ABCDEF <i>G</i> abcde <i>fg</i> 0123456789&?!.,'
81	Courier Italic «Esc»(Symbol set«Esc»(s0p«pitch»h1s0b4099T	'ABCDEF <i>G</i> abcde <i>fg</i> 0123456789&?!.,'
82	Courier Bold Italic «Esc»(Symbol set«Esc»(s0p«pitch»h1s3b4099T	'ABCDEF <i>G</i> abcde <i>fg</i> 0123456789&?!.,'
83	Letter Gothic «Esc»(Symbol set«Esc»(s0p«pitch»h0s0b4102T	'ABCDEF <i>G</i> abcde <i>fg</i> 0123456789&?!.,'
84	Letter Gothic Bold «Esc»(Symbol set«Esc»(s0p«pitch»h0s3b4102T	'ABCDEF <i>G</i> abcde <i>fg</i> 0123456789&?!.,'
85	Letter Gothic Italic «Esc»(Symbol set«Esc»(s0p«pitch»h1s0b4102T	'ABCDEF <i>G</i> abcde <i>fg</i> 0123456789&?!.,'
86	Naskh «Esc»(Symbol set«Esc»(s0p«pitch»h0s0b4124T	ABCDEF <i>G</i> abcde <i>fg</i> 0123456789&?!.,'
87	Naskh Bold «Esc»(Symbol set«Esc»(s0p«pitch»h0s3b4124T	ABCDEF <i>G</i> abcde <i>fg</i> 0123456789&?!.,'
88	Koufi «Esc»(Symbol set«Esc»(s0p«pitch»h0s0b4264T	ABCDEF <i>G</i> abcde <i>fg</i> 0123456789&?!.,'
89	Koufi Bold «Esc»(Symbol set«Esc»(s0p«pitch»h0s3b4264T	ABCDEF <i>G</i> abcde <i>fg</i> 0123456789&?!.,'
90	Courier PS «Esc»(Symbol set«Esc»(s0p«pitch»h0s0b24579T	'ABCDEF <i>G</i> abcde <i>fg</i> 0123456789&?!.,'

Resident Fonts

Position	Font Name	Print Sample
91	Courier PS Bold «Esc»(Symbol set«Esc»(s0p«pitch»h0s3b24579T	' ABCDEFGGabcdefg0123456789&?!.,'
92	Courier PS Oblique «Esc»(Symbol set«Esc»(s0p«pitch»h1s0b24579T	' <i>ABCDEFGGabcdefg0123456789&?!.,'</i>
93	Courier PS Bold Oblique «Esc»(Symbol set«Esc»(s0p«pitch»h1s3b24579T	' <i>ABCDEFGGabcdefg0123456789&?!.,'</i>
93	Line Printer «Esc»(8U«Esc»(s0p16.67h8.48v0s0b0T	'ABCDEFGabcdefg0123456789&?!.,'

